

RDCD20



MODULO DI RECUPERO SENZA VENTILATORI UTILIZZO IN SISTEMA CENTRALIZZATO

Recuperatore di calore: in controcorrente interamente realizzato in materiale plastico.

Struttura: autoportante in HMPEPS a tenuta completa di sistema estrazione filtri e drenaggio condensa.

Filtri: le unità sono provviste di serie con celle filtranti ondulate in fibra sintetica classe G4, in opzione filtro efficienza F7 su aria esterna.

RECOVERY MODULE WITHOUT FANS USE IN CENTRALIZED SYSTEM

Heat recovery: heat exchanger of the type in countercurrent entirely made of plastic material.

Structure: free standing HMPEPS seal, complete of filters ex traction system and drain condensate.

Filters: the units are equipped with standard filter cells synthetic fiber efficiency G4, optional F7 efficiency on fresh air.



COMPONENTES PARA REFRIGERAÇÃO, LDA.

FILTRI | FILTERS

Efficienza | Efficiency Standard

G4
ISO COARSE > 65 %

Efficienza | Efficiency Optional

F7
ISO e PM1 > 65 %



DISEGNI | DRAWINGS

PESO | WEIGHT: 7 kg

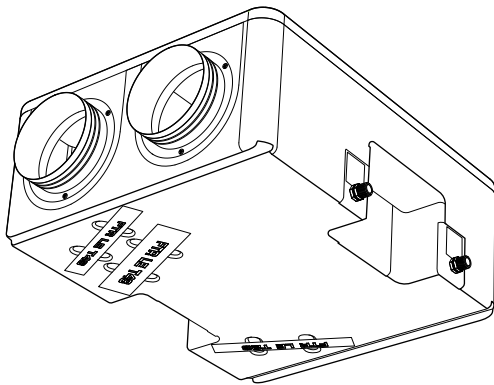

Vista dal basso | Bottom View

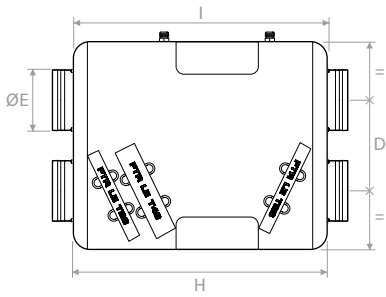

Vista interna | Internal view

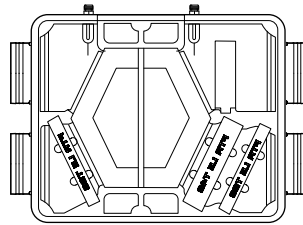

Vista laterale | Side view

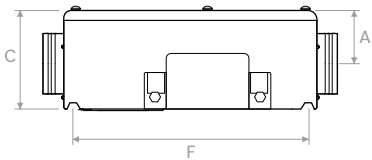

Vista frontale | Front view

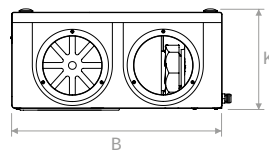

Vista in pianta | Plan view

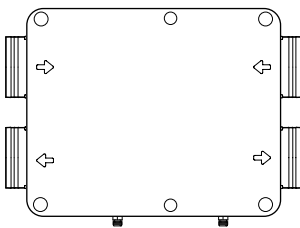

	A	B	C	D	ØE	F	H	I	K
mm	149	550	255	243	156	620	670	770	268

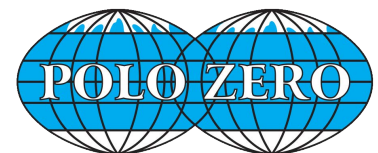

COMPONENTES PARA REFRIGERAÇÃO, LDA.



SCAMBIATORE CERTIFICATO EN 308 | HEAT EXCHANGER EN 308 CERTIFIED

RDCD20

Diagramma efficienza estiva

Aria esterna: 32 °C / 50 % U.R.

Aria ambiente: 26 °C / 50 % U.R.

Summer efficiency chart

Fresh air: 32 °C / 50 % R.H.

Return air: 26 °C / 50 % R.H.



Diagramma efficienza invernale

Aria esterna: - 5 °C / 80 % U.R.

Aria ambiente: 20 °C / 50 % U.R.

Winter efficiency chart

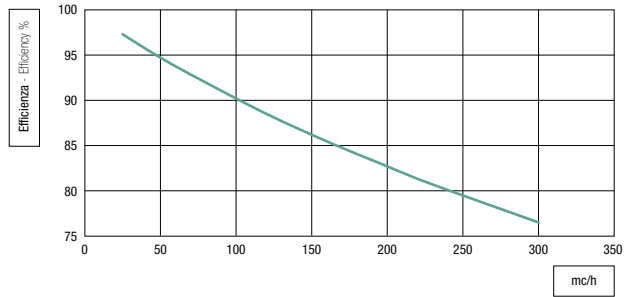
Fresh air: - 5 °C / 80 % R.H.

Return air: 20 °C / 50 % R.H.

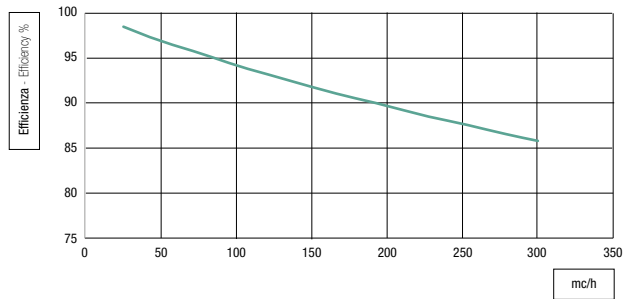

PREZZI | PRICES

Modello Model	Descrizione Description	€
RDCD20		-
FTRLET23	Kit filtri ricambio (2 pz) efficienza G4 Replacement filter kit (2 pcs) efficiency G4	-
FTRLET48	Filtro ricambio efficienza F7 Replacement filter efficiency F7	-

